



US 20190305254A1

(19) **United States**

(12) **Patent Application Publication**
KIM et al.

(10) **Pub. No.: US 2019/0305254 A1**
(43) **Pub. Date: Oct. 3, 2019**

(54) **ORGANIC LIGHT EMITTING DIODE DISPLAY**

Publication Classification

(71) Applicant: **SAMSUNG DISPLAY CO., LTD.**,
Yongin-si (KR)

(51) **Int. Cl.**
H01L 51/52 (2006.01)
H01L 51/00 (2006.01)

(72) Inventors: **Won Jong KIM**, Suwon-si (KR); **Dong Chan KIM**, Gunpo-si (KR); **Eung Do KIM**, Seoul (KR); **Dong Kyu SEO**, Hwaseong-si (KR); **Da Hea IM**, Incheon (KR); **Sang Hoon YIM**, Suwon-si (KR); **Yoon Hyeung CHO**, Yongin-si (KR); **Won Suk HAN**, Yongin-si (KR)

(52) **U.S. Cl.**
CPC *H01L 51/5275* (2013.01); *H01L 51/0073* (2013.01); *H01L 51/0074* (2013.01); *H01L 27/3211* (2013.01); *H01L 51/5262* (2013.01); *H01L 51/0061* (2013.01); *H01L 51/5253* (2013.01); *H01L 51/0072* (2013.01)

(21) Appl. No.: **16/427,978**

(57) **ABSTRACT**

(22) Filed: **May 31, 2019**

An organic light emitting diode display including: a substrate; an organic light emitting diode on the substrate; a capping layer on the organic light emitting diode and including a high refractive layer including an inorganic material having a refractive index that is equal to or greater than about 1.7 and equal to or less than about 6.0; and a thin film encapsulation layer covering the capping layer and the organic light emitting diode, the inorganic material including at least one selected from the group consisting of CuI, thallium iodide (TlI), BaS, Cu₂O, CuO, BiI, WO₃, TiO₂, AgI, CdI₂, HgI₂, SnI₂, PbI₂, BiI₃, ZnI₂, MoO₃, Ag₂O, CdO, CoO, Pr₂O₃, SnS, PbS, CdS, CaS, ZnS, ZnTe, PbTe, CdTe, SnSe, PbSe, CdSe, AlAs, GaAs, InAs, GaP, InP, AlP, AlSb, GaSb, and InSb.

Related U.S. Application Data

(62) Division of application No. 15/087,808, filed on Mar. 31, 2016, now Pat. No. 10,361,400.

Foreign Application Priority Data

Jun. 25, 2015 (KR) 10-2015-0090722

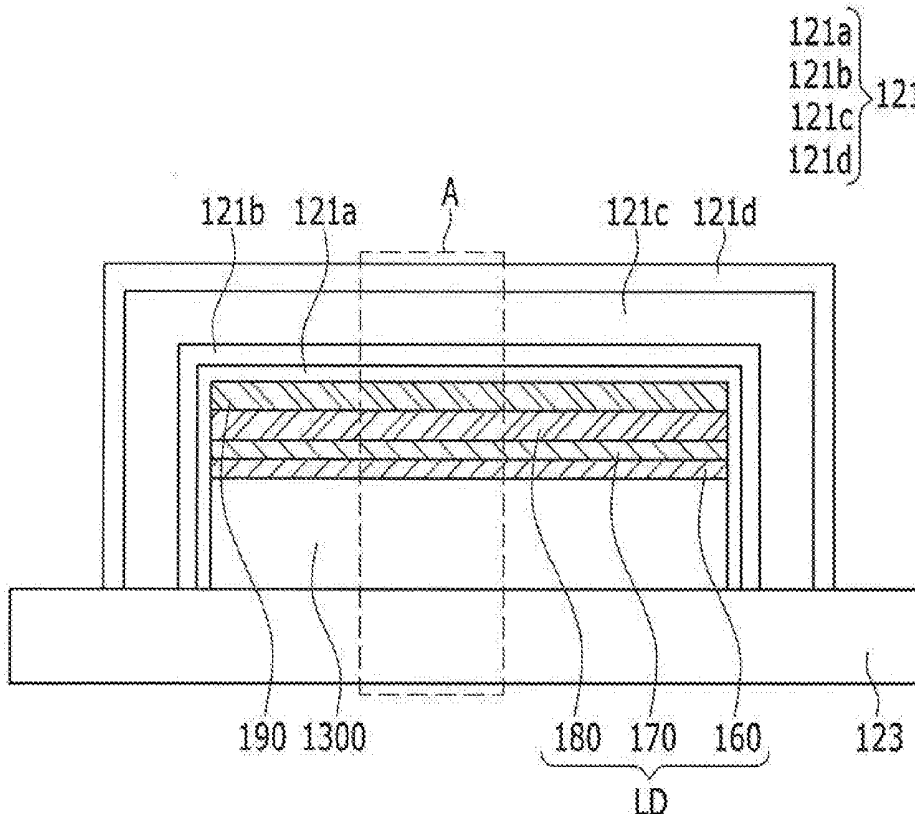

FIG. 1

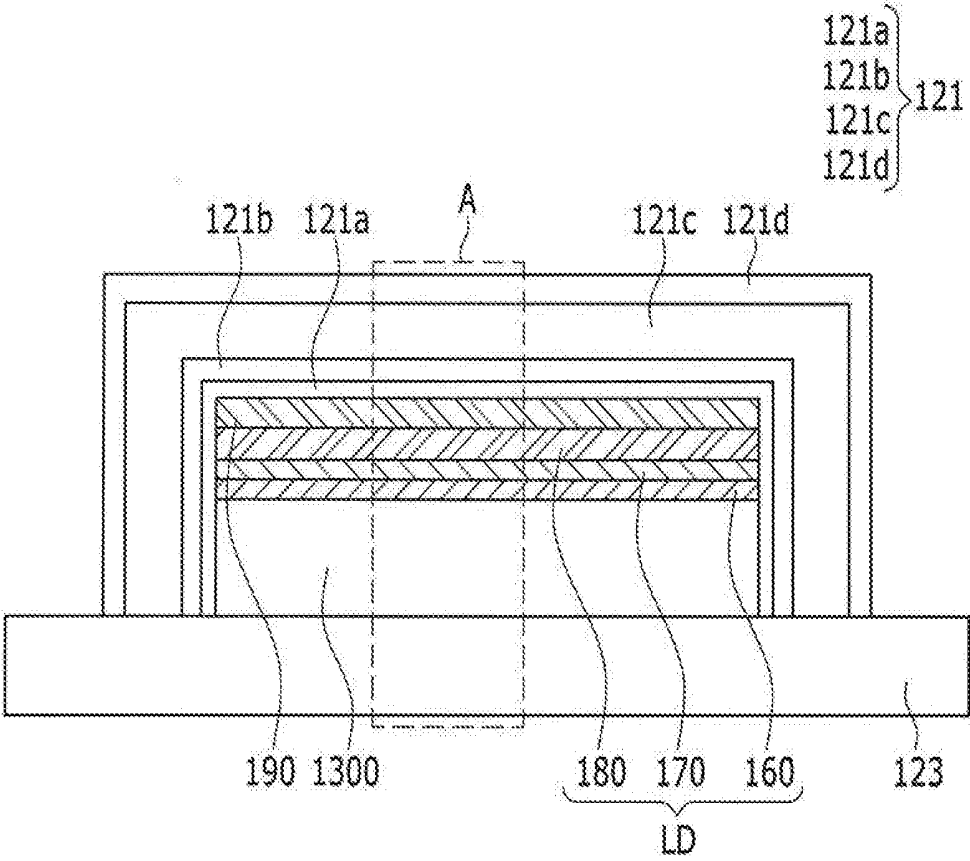

FIG. 2

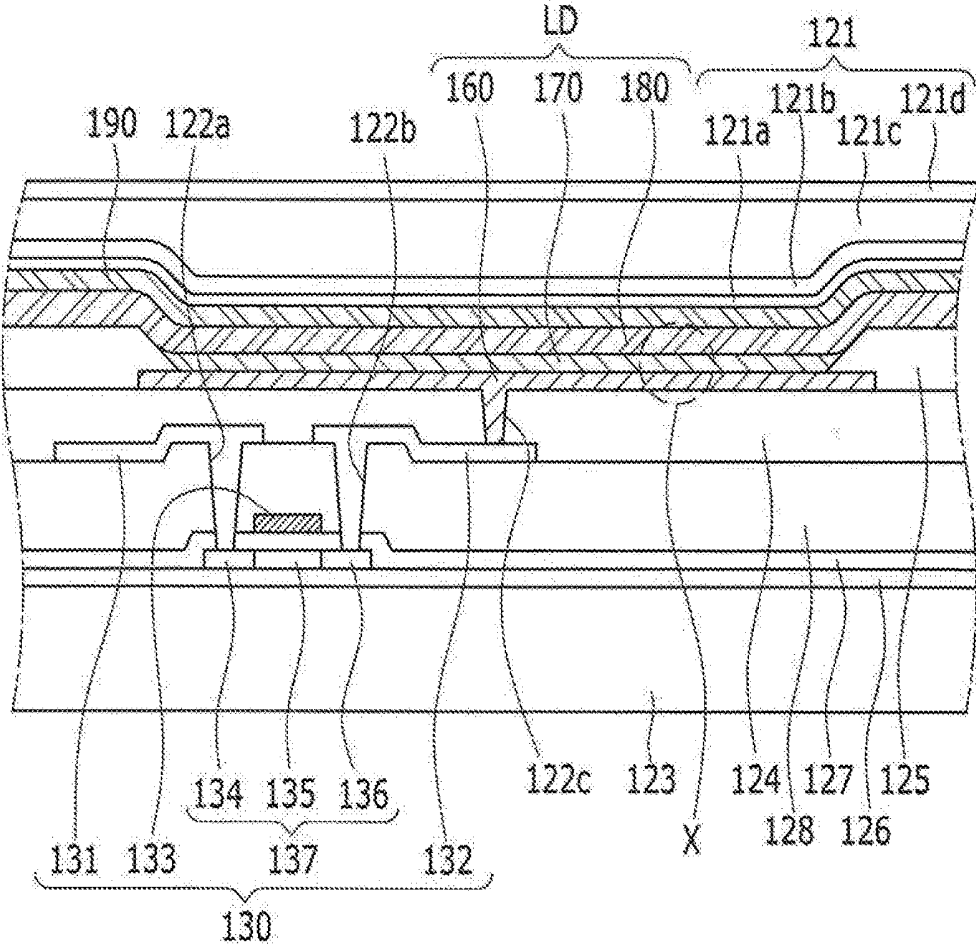

FIG. 3

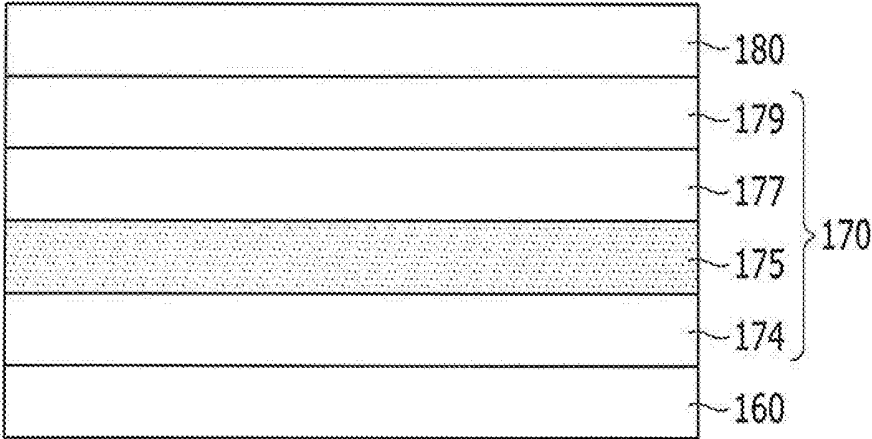

FIG. 4

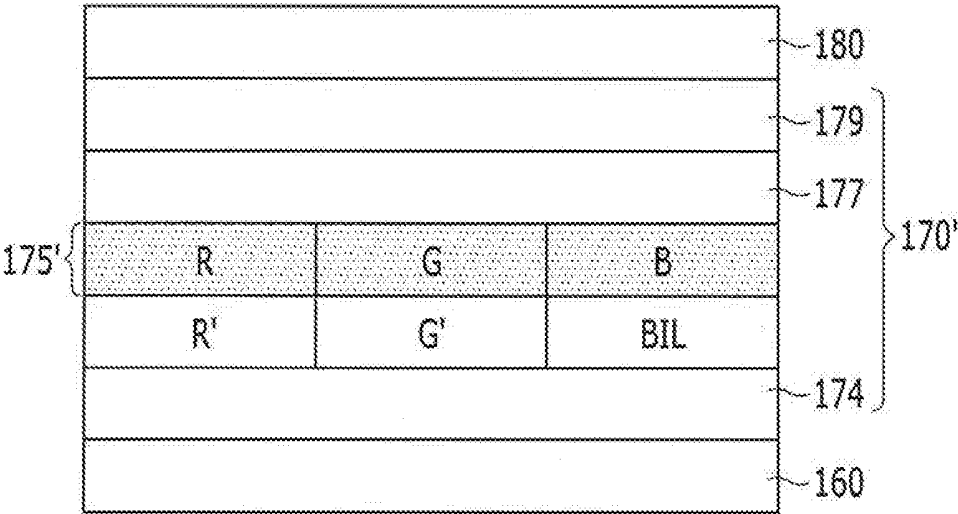
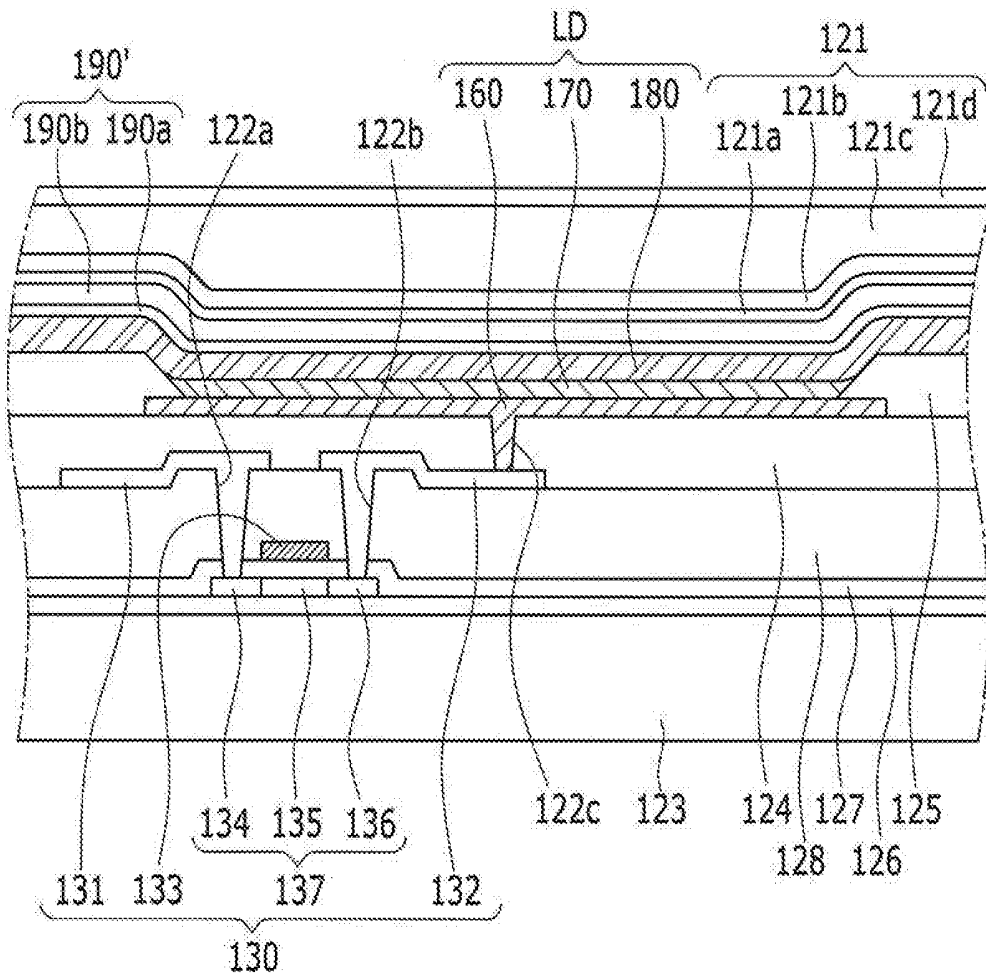

FIG. 5



ORGANIC LIGHT EMITTING DIODE DISPLAY

CROSS-REFERENCE TO RELATED APPLICATIONS

[0001] This application is a divisional of U.S. patent application Ser. No. 15/087,808, filed on Mar. 31, 2016, which claims priority to and the benefit of Korean Patent Application No. 10-2015-0090722, filed on Jun. 25, 2015 in the Korean Intellectual Property Office, the entire content of each of which is incorporated herein by reference.

BACKGROUND

1. Field

[0002] Aspects of embodiments of the present disclosure relate to an organic light emitting diode display.

2. Description of the Related Art

[0003] The recent trend toward lightweight and thin personal computers and television sets necessitates lightweight and thin display devices, and flat panel displays (e.g., a liquid crystal display (LCD)) satisfying such requirements are being substituted for conventional cathode ray tubes (CRTs). However, since an LCD is a passive display device, an additional backlight is needed as a light source, and LCDs have various problems, such as a slow response time and a narrow viewing angle.

[0004] In this regard, an organic light emitting diode (OLED) display has recently been highlighted as a self-emissive display device with advantages of a wide viewing angle, outstanding contrast, and a fast response time.

[0005] The OLED display includes organic light emitting diodes for emitting light, and in the OLEDs, electrons injected from one electrode and holes injected from another electrode are combined with each other in a light emitting layer, thereby generating excitons, and energy is outputted from the excitons to emit light.

[0006] Currently, various methods that can improve light efficiency by effectively extracting light that is generated in the organic light emitting layer are necessitated.

[0007] The above information disclosed in this Background section is only to enhance the understanding of the background of the disclosure and therefore it may contain information that does not form the prior art that is already known in this country to a person of ordinary skill in the art.

SUMMARY

[0008] According to an aspect of embodiments of the present disclosure, an organic light emitting diode display has improved light efficiency.

[0009] According to one or more exemplary embodiments of the present disclosure, an organic light emitting diode display includes: a substrate; an organic light emitting diode on the substrate; a capping layer on the organic light emitting diode and including a high refractive layer including an inorganic material having a refractive index that is equal to or greater than about 1.7 and equal to or less than about 6.0; and a thin film encapsulation layer covering the capping layer and the organic light emitting diode, and the inorganic material may include at least one selected from the group consisting of CuI, thallium iodide (TlI), BaS, Cu₂O, CuO, BiI, WO₃, TiO₂, AgI, CdI₂, HgI₂, SnI₂, PbI₂, BiI₃,

ZnI₂, MoO₃, Ag₂O, CdO, CoO, Pr₂O₃, SnS, PbS, CdS, CaS, ZnS, ZnTe, PbTe, CdTe, SnSe, PbSe, CdSe, AlAs, GaAs, InAs, GaP, InP, AlP, AlSb, GaSb, and InSb.

[0010] The capping layer may include a top layer directly below the thin film encapsulation layer, the thin film encapsulation layer may include a base layer directly on the capping layer, and the top layer and the base layer may have different refractive indexes.

[0011] The thin film encapsulation layer may include a first encapsulation layer on the base layer, a second encapsulation layer on the first encapsulation layer, and a third encapsulation layer on the second encapsulation layer; the first encapsulation layer may be an inorganic layer; the second encapsulation layer may be an organic layer; and the third encapsulation layer may be an inorganic layer.

[0012] The base layer may include at least one selected from the group consisting of LiF, SiOx, SiC, MgF₂, AlF₃, and NaF.

[0013] The first encapsulation layer may include at least one selected from the group consisting of SiON, TiO₂, and SiNx.

[0014] The third encapsulation layer may include at least one selected from the group consisting of SiON, SiNx, and TiO₂.

[0015] The capping layer may further include a low refraction layer formed of an inorganic material with a refractive index that is equal to or greater than about 1.0 and equal to or less than about 1.7.

[0016] The low refraction layer may be disposed between the high refractive layer and the organic light emitting diode.

[0017] The low refraction layer may include an inorganic material that includes a halogen compound.

[0018] The low refraction layer may include at least one selected from the group consisting of MgF₂, LiF, AlF₃, and NaF.

[0019] The low refraction layer may include at least one low refraction layer, and the high refractive layer may include at least one high refractive layer, and the capping layer may have a structure in which the low refraction layer and the high refractive layer are alternately stacked.

[0020] The organic light emitting diode may include a first electrode and a second electrode facing each other, and a light-emitting layer between the first electrode and the second electrode, and the capping layer may be directly on the second electrode.

[0021] The first electrode may be formed as a reflective layer.

[0022] The thin film encapsulation layer may be formed to cover a lateral surface of the capping layer.

[0023] The light-emitting layer may include a red light-emitting layer, a green light-emitting layer, a blue light-emitting layer, and an auxiliary layer that is below the blue light-emitting layer.

[0024] The organic light emitting diode display may further include a red resonant auxiliary layer below the red light-emitting layer and a green resonant auxiliary layer below the green light-emitting layer.

[0025] The auxiliary layer may include a compound represented by Chemical Formula 1.

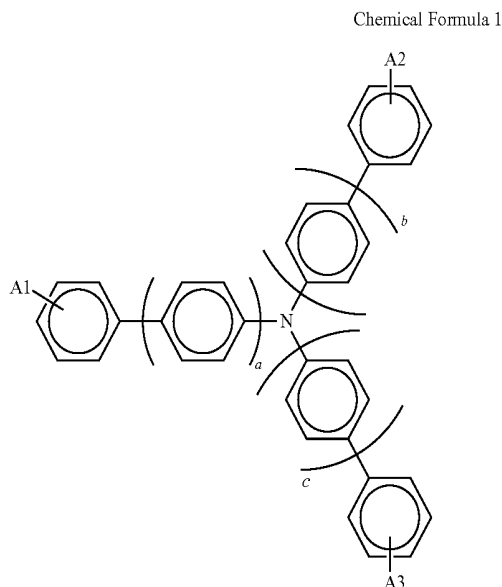

[0026] In Chemical Formula 1, A1, A2, and A3 are each an alkyl group, an aryl group, carbazole, dibenzothiophene, dibenzofuran (DBF), and biphenyl, and a, b, and c are each positive numbers of zero to four.

[0027] The auxiliary layer may include a compound represented by Chemical Formula 2.

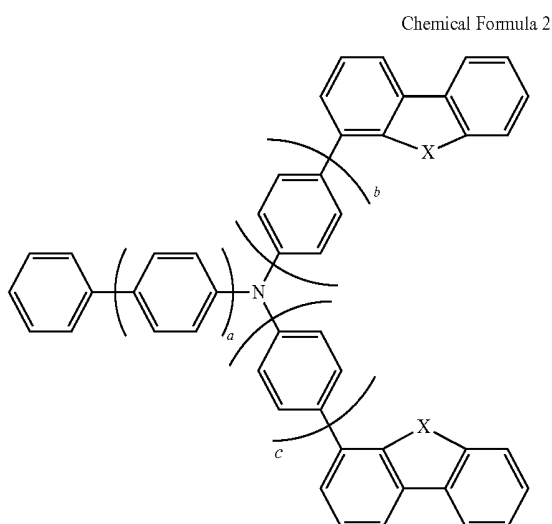

[0028] In Chemical Formula 2, a may be 0 to 3, b and c may respectively be 0 to 3, X may be selected from O, N, or S, and each X may be the same as the other or different than the other.

[0029] According to an aspect of embodiments of the present disclosure, light efficiency of an organic light emitting diode display is improved by forming a capping layer with an inorganic material that has a high refractive index. Further, according to an aspect of embodiments of the present disclosure, light efficiency is improved by providing

a top layer of a capping layer and a base layer of a thin film encapsulation layer having different refractive indexes.

BRIEF DESCRIPTION OF THE DRAWINGS

[0030] FIG. 1 illustrates a cross-sectional view of an organic light emitting diode display according to an exemplary embodiment of the present disclosure.

[0031] FIG. 2 illustrates an enlarged cross-sectional view in which a region "A" of FIG. 1 is shown enlarged.

[0032] FIG. 3 illustrates an enlarged cross-sectional view of an organic light emitting diode in which a region "X" of FIG. 2 is shown enlarged.

[0033] FIG. 4 illustrates a cross-sectional view of another exemplary embodiment in which the organic light emitting diode of FIG. 3 is partially modified.

[0034] FIG. 5 illustrates a cross-sectional view of another exemplary embodiment in which a capping layer of the organic light emitting diode display of FIG. 2 is partially modified.

DETAILED DESCRIPTION

[0035] Aspects and features of the present disclosure will be described more fully hereinafter with reference to the accompanying drawings, in which some exemplary embodiments of the disclosure are shown. However, it is to be understood that the disclosure is not limited to the disclosed embodiments, but, on the contrary, is intended to cover various modifications. As those skilled in the art would realize, the described embodiments may be modified in various different ways, all without departing from the spirit or scope of the present disclosure.

[0036] In the drawings, the thickness of layers, films, panels, regions, etc., may be exaggerated for clarity. It will be understood that when an element such as a layer, film, region, or substrate is referred to as being "on" another element, it can be directly on the other element or intervening elements may also be present. Like reference numerals designate like elements throughout the specification.

[0037] FIG. 1 illustrates a cross-sectional view of an organic light emitting diode display according to an exemplary embodiment of the present disclosure. FIG. 2 illustrates an enlarged cross-sectional view in which a region "A" of FIG. 1 is shown enlarged. FIG. 3 illustrates an enlarged cross-sectional view of an organic light emitting diode in which a region "X" of FIG. 2 is shown enlarged.

[0038] Referring to FIG. 1, an organic light emitting diode display according to an exemplary embodiment of the present disclosure includes a substrate 123, a thin film transistor element layer 1300 disposed on the substrate 123 and including a gate line, a data line, a thin film transistor, an interlayer insulating layer, and the like, and an organic light emitting diode LD disposed on the thin film transistor element layer 1300. The organic light emitting diode LD includes a first electrode 160, a light-emitting diode layer 170, and a second electrode 180. The first electrode 160 may be a hole injection electrode and the second electrode 180 may be an electron injection electrode. A hole supplied through the first electrode 160 and an electron supplied through the second electrode 180 are combined in the light-emitting diode layer 170 to generate light. In contrast, the first electrode 160 may be an electron injection electrode and the second electrode 180 may be a hole injection electrode. An electron supplied through the first electrode

160 and a hole supplied through the second electrode **180** are combined in the light-emitting diode layer **170** to generate light.

[0039] In order to further adjust light characteristics such as efficiency and a viewing angle of the organic light emitting diode LD, a capping layer **190** for the organic light emitting diode LD is provided. Since the organic light emitting diode LD is very vulnerable to a gas such as oxygen or moisture, a thin film encapsulation layer **121**, in one embodiment, is disposed to surround an upper surface and a lateral surface of the capping layer **190** so as to prevent or substantially prevent external air or moisture from permeating into the organic light emitting diode LD.

[0040] A stacked structure of the organic light emitting diode display according to an exemplary embodiment of the present disclosure will now be described in further detail with reference to FIGS. 2 and 3.

[0041] Referring to FIGS. 2 and 3, the organic light emitting diode display according to an exemplary embodiment of the present disclosure includes the substrate **123**, a thin film transistor **130**, the first electrode **160**, the light-emitting diode layer **170**, and the second electrode **180**. The first electrode **160** may be an anode and the second electrode **180** may be a cathode, or, alternatively, the first electrode **160** may be a cathode and the second electrode **180** may be an anode.

[0042] The substrate **123** may be made of an inorganic material such as glass, an organic material such as polycarbonate, polymethyl methacrylate, polyethylene terephthalate, polyethylene naphthalate, polyamide, polyether sulfone, or a combination thereof, or a silicon wafer.

[0043] A substrate buffer layer **126** may be disposed on the substrate **123**. The substrate buffer layer **126** serves to prevent or substantially prevent penetration of impurity elements and to flatten a surface.

[0044] In this case, the substrate buffer layer **126** may be made of any of a variety of materials that can perform the above-described functions. For example, any of a silicon nitride (SiNx) layer, a silicon oxide (SiOy) layer, and a silicon oxynitride (SiOyNx) layer may be used as the substrate buffer layer **126**. However, in another embodiment, since the substrate buffer layer **126** is not an integral component, it may be omitted depending on a kind of the substrate **123** and a processing condition.

[0045] A driving semiconductor layer **137** is formed on the substrate buffer layer **126**. The driving semiconductor layer **137** is formed of a material including polysilicon. In addition, the driving semiconductor layer **137** includes a channel area **135** in which impurities are not doped, and a source area **134** and a drain area **136** in which impurities are doped at opposite sides of the channel area **135**. In this case, dopant materials are P-type impurities such as boron (B), and B₂H₆ may be used. In this case, impurities may be dependent on kinds of thin film transistors.

[0046] A gate insulating layer **127** that is made of a silicon nitride (SiNx) or a silicon oxide (SiOy) is formed on the driving semiconductor layer **137**. A gate line including a driving gate electrode **133** is formed on the gate insulating layer **127**. In addition, the driving gate electrode **133** may be formed to overlap at least some of the driving semiconductor layer **137**, and specifically, the channel region **135**.

[0047] An interlayer insulating layer **128** covering the driving gate electrode **133** is formed on the gate insulating layer **127**. First and second contact holes **122a** and **122b**

exposing the source and drain regions **134** and **136** of the driving semiconductor layer **137** are formed in the gate insulating layer **127** and the interlayer insulating layer **128**. The interlayer insulating layer **128** may be made of a silicon nitride (SiNx) or a silicon oxide (SiOy), as may be the gate insulating layer **127**.

[0048] In addition, a data line including a driving source electrode **131** and a driving drain electrode **132** may be disposed on the interlayer insulating layer **128**. The driving source electrode **131** and the driving drain electrode **132** are connected to the source and drain regions **134** and **136**, respectively, of the driving semiconductor layer **137** via the first and second contact holes **122a** and **122b** that are respectively formed in the interlayer insulating layer **128** and the gate insulating layer **127**.

[0049] As such, the driving thin film transistor **130** is formed by including the driving semiconductor layer **137**, the driving gate electrode **133**, the driving source electrode **131**, and the driving drain electrode **132**. However, in other embodiments, the configuration of the driving thin film transistor **130** is not limited to the example described above, and can be modified in various ways to have any of suitable configurations that can be easily practiced by those skilled in the art.

[0050] In addition, a planarization layer **124** covering the data line is formed on the interlayer insulating layer **128**. The planarization layer **124** serves to eliminate or reduce and flatten a step to increase luminous efficiency of the organic light emitting diode to be formed thereon. The planarization layer **124** includes a third contact hole **122c** that exposes a portion of the drain electrode **132**.

[0051] The planarization layer **124** may be made of one or more of a polyacrylate resin, an epoxy resin, a phenolic resin, a polyamide resin, a polyimide resin, an unsaturated polyester resin, a polyphenylene ether resin, a polyphenylene sulfide resin, and benzocyclobutene (BCB).

[0052] Here, the exemplary embodiment according to the present disclosure is not limited to the structure described above, and, in one embodiment, either of the planarization layer **124** and the interlayer insulating layer **128** may be omitted.

[0053] In this case, the first electrode **160** corresponding to a pixel electrode of the organic light emitting diode LD is formed on the planarization layer **124**. That is, the organic light emitting diode display includes the plurality of first electrodes **160** that are respectively disposed in a plurality of pixels. In this case, the first electrodes **160** are disposed to be spaced apart from each other. The first electrode **160** is connected to the drain electrode **132** via the third contact hole **122c** of the planarization layer **124**.

[0054] Pixel definition layers **125** including an opening exposing the first electrode **160** are formed on the planarization layer **124**. That is, a plurality of openings corresponding to each of the pixels is formed between the pixel definition layers **125**. In this case, a light-emitting diode layer **170** may be disposed in each of the openings that are formed by the pixel definition layer **125**. Accordingly, a pixel area in which each of organic light-emitting layers are formed may be defined by the pixel definition layer **125**.

[0055] In this case, the first electrode **160** is disposed to correspond to the openings of the pixel definition layer **125**. However, the first electrode **160** may not necessarily be disposed only in the opening of the pixel definition layer

125, but may be disposed below the pixel definition layer **125** such that some of the first electrode **160** overlaps the pixel definition layer **125**.

[0056] The pixel definition layer **125** may be made of a polyacrylate-based resin and a polyimide-based resin, or a silica-based inorganic material.

[0057] The light-emitting diode layer **170** is formed on the first electrode **160**. A structure of the light-emitting diode layer **170** is described further below.

[0058] The second electrode **180** corresponding to a common electrode may be formed on the light-emitting diode layer **170**. As such, the organic light emitting diode LD including the first electrode **160**, the light-emitting diode layer **170**, and the second electrode **180** is formed.

[0059] The first electrode **160** and the second electrode **180** may be respectively made of a transparent conductive material or a transfective or reflective conductive material. Depending on kinds of materials for forming the first electrode **160** and the second electrode **180**, the organic light emitting diode display may be a top emission type, a bottom emission type, or a dual emission type. In the organic light emitting diode display according to the present exemplary embodiment, the first electrode **160** is formed as a reflective layer and the second electrode **180** is formed as a transfective layer, such that light generated by the light-emitting diode layer **170** may pass through the second electrode **180** to be outputted outside. In other words, the organic light emitting diode display of the present exemplary embodiment may include a top emission type of cavity structure.

[0060] The second electrode **180** included in the organic light emitting diode according to an exemplary embodiment of the present disclosure may include at least one selected from the group consisting of Ag, Al, Mg, Cr, Mn, Fe, Co, Ni, Cu, In, Sn, Ru, Mo, and Nb. The second electrode **180** of the present exemplary embodiment may be deposited by sputtering.

[0061] The capping layer **190** is disposed on the second electrode **180** to cover and protect the second electrode **180**. In the present exemplary embodiment, the capping layer **190** includes an inorganic material with a refractive index which is equal to or greater than about 1.7 and equal to or less than about 6.0. In the present exemplary embodiment, the inorganic material forming the capping layer **190** may include a material selected from CuI, thallium iodide (TlI), BaS, Cu₂O, CuO, BiI, and WO₃. Specifically, the inorganic material such as CuI, BiI, or TlI is a high refractive material, which is capable of thermal evaporation at a temperature of less than about 500 degrees Celsius and is capable of deposition by a thermal evaporation method at a relatively low temperature, thereby strengthening a cavity without changing electrical characteristics with respect to the organic light emitting diode LD. Accordingly, when the capping layer **190** is formed of the inorganic material such as CuI, BiI, or TlI, light efficiency may be improved without changing electrical characteristics of the organic light emitting diode LD.

[0062] The capping layer **190** is not limited to the above-described exemplary embodiment, and the capping layer **190** may include at least one selected from TiO₂, AgI, CdI₂, HgI₂, SnI₂, PnI₂, BiI₃, ZnI₂, MoO₃, Ag₂O, CdO, CoO, Pr₂O₃, SnS, PbS, CdS, CaS, ZnS, ZnTe, PbTe, CdTe, SnSe, PbSe, CdSe, AlAs, GaAs, InAs, GaP, InP, AlP, AlSb, GaSb, and InSb.

[0063] The capping layer **190** shown in FIGS. 1 and 2 is described as a single layer, but the present disclosure is not limited thereto, and the capping layer **190** may include two or more layers, which will be described further later.

[0064] The thin film encapsulation layer **121** is formed on the capping layer **190**. The thin film encapsulation layer **121** seals and protects the organic light emitting diode LD and a driving circuit unit, which are formed on the substrate **123**, from the outside.

[0065] In one embodiment, the thin film encapsulation layer **121** includes a base layer **121a**, a first encapsulation layer **121b**, a second encapsulation layer **121c**, and a third encapsulation layer **121d** that are stacked on one another. The base layer **121a** is directly disposed on the capping layer **190** to contact an upper surface of the capping layer **190**. The base layer **121a** according to the present exemplary embodiment may have a refractive index different from that of the capping layer **190**. For example, as described above, when the capping layer **190** is formed as a high refraction layer, the base layer **121a** may be formed as a low refraction layer. The base layer **121a** formed as the low refraction layer may include any of LiF, SiOx, SiC, Mg F₂, AlF₃, and NaF.

[0066] A capping layer **190** according to a modified exemplary embodiment of the present disclosure may be formed of an organic material such as Balq having a low refractive index equal to or less than about 1.7 or an inorganic material such as AlF₃, and, in this case, the base layer **121a** may include a material selected from SiNx, TiO₂, CuI, and TlI.

[0067] In one embodiment, the first encapsulation layer **121b**, the second encapsulation layer **121c**, and the third encapsulation layer **121d** are sequentially stacked on the base layer **121a**. According to the present exemplary embodiment, the first encapsulation layer **121b** may be an inorganic layer, the second encapsulation layer **121c** may be an organic layer, and the third encapsulation layer **121d** may be an inorganic layer. The first encapsulation layer **121b** may include at least one selected from the group consisting of SiON, TiO₂, and SiNx, and the third encapsulation layer **121d** may include at least one selected from the group consisting of SiON, SiNx, and TiO₂. An oxide or nitride such as SiON or SiNx included in the first encapsulation layer **121b** may be deposited by a chemical vapor deposition method, and an oxide such as TiO₂ included in the first encapsulation layer **121b** may be deposited by an atomic layer deposition method. In the present exemplary embodiment, although the first encapsulation layer **121b** is formed as a single layer, the first encapsulation layer **121b** may be formed as a two-layered structure including a lower layer and an upper layer. In this case, each of the lower layer and the upper layer may include a material selected from SiON, TiO₂, and SiNx.

[0068] An organic light emitting diode according to an exemplary embodiment of the present disclosure will now be described with reference to FIG. 3.

[0069] Referring to FIG. 3, an organic light emitting diode (shown at region "X" of FIG. 2) according to an exemplary embodiment of the present disclosure includes a structure in which the first electrode **160**, a hole-transporting layer **174**, a light-emitting layer **175**, an electron-transporting layer **177**, an electron injection layer **179**, and the second electrode **180** are sequentially stacked.

[0070] When the first electrode **160** is an anode, a material selected from materials having a high work function may be selected for injection of holes. The first electrode **160** may

be a transparent electrode or an opaque electrode. When the first electrode **160** is a transparent electrode, it may be made of indium-tin oxide (ITO), indium-zinc oxide (IZO), tin oxide (SnO₂), zinc oxide (ZnO), or a combination thereof, which is a conductive oxide, or a metal such as aluminum, silver, and magnesium, with a thin thickness. When the first electrode **160** is an opaque electrode, it may be made of a metal, such as aluminum, silver, or magnesium.

[0071] The first electrode **160** may be formed in a two or more-layered structure including different kinds of materials. For example, the first electrode **160** may be formed to have a structure in which indium-tin oxide (ITO)/silver (Ag)/indium-tin oxide (ITO) are sequentially stacked.

[0072] The first electrode **160** may be formed by sputtering or vacuum deposition.

[0073] The hole-transporting layer **174** is disposed on the first electrode **160**. The hole-transporting layer **174** may serve to smoothly transport holes transmitted from a hole injection layer (not shown). The hole-transporting layer **174** may include an organic material. For example, the hole transporting layer **174** may include NPD (N,N'-dinaphthyl-N,N'-diphenyl benzidine), TPD (N,N'-bis-(3-methylphenyl)-N,N'-bis-(phenyl)-benzidine), s-TAD, MTDATA (4,4',4''-tris (N-3-methylphenyl-N-phenyl-amino)-triphenylamine), etc., but is not limited thereto.

[0074] In this case, the thickness of the hole-transporting layer **174** may be about 15 nm to about 25 nm. In an exemplary embodiment, the thickness of hole-transporting layer **174** may be about 20 nm. The hole-transporting layer and the hole-injection layer may be formed to be a single layer by modifying the above-described hole-transporting layer **174** and including a hole injecting material in the hole-transporting layer **174**.

[0075] The light-emitting layer **175** is disposed on the hole-transporting layer **174**. The light-emitting layer **175** includes a light-emitting material that represents a specific color. For example, the light-emitting layer **175** may display a basic color such as blue, green, or red, or a combination thereof.

[0076] The thickness of the light-emitting layer **175** may be about 10 nm to about 50 nm. The light-emitting layer **175** includes a host and a dopant. The light-emitting layer **175** may include a material that emits red light, green light, blue light, and white light, and may be formed using a phosphorescent or fluorescent material.

[0077] When emitting red light, the light-emitting layer **175** includes a host material that includes CBP (carbazole biphenyl) or mCP (1,3-bis(carbazol-9-yl)), and may be made of a phosphorescent material including a dopant including at least one selected from PIQIr(acac) (bis(1-phenylisoquinoline)acetylacetonate iridium), PQIr(acac) (bis(1-phenylquinoline)acetylacetonate iridium), PQIr(tris(1-phenylquinoline)iridium), and PtOEP (octaethylporphyrin platinum), or, alternatively, may be made of a fluorescent material including PBD:Eu(DBM)3(Phen) or perylene, but is not limited thereto.

[0078] When emitting green light, the light-emitting layer **175** includes a host material that includes CBP or mCP, and may be made of a phosphorescent material that includes a dopant material including Ir(ppy)3(fac-tris(2-phenylpyridine)iridium), or alternatively, may be made of a fluorescent material including Alq3(tris(8-hydroxyquinolino)aluminum), but it is not limited thereto.

[0079] When emitting blue light, the light-emitting layer **175** includes a host material including CBP or mCP, and may be made of a phosphorescent material that includes a dopant material including (4,6-F2ppy)2Irpic. Alternatively, the light-emitting layer **175** may be made of a fluorescent material including at least one selected from a group of spiro-DPVBi, spiro-6P, distyryl benzene (DSB), distyrylarylene (DSA), a PFO-based polymer, and a PPV-based polymer, but is not limited thereto.

[0080] The electron-transporting layer **177** is disposed on the light-emitting layer **175**. The electron-transporting layer **177** may transmit electrons from the second electrode **180** to the light-emitting layer **175**. Further, the electron-transporting layer **177** can prevent or substantially prevent holes injected from the first electrode **160** from moving to the second electrode **180** through the light-emitting layer **175**. That is, the electron-transporting layer **177** functions as a hole-blocking layer to help combination of the holes and electrons in the light-emitting layer **175**.

[0081] In this case, the electron-transporting layer **177** may include an organic material. For example, the electron-transporting layer **177** may include at least one selected from the group consisting of Alq3 (tris(8-hydroxyquinolino)-aluminum), PBD, TAZ, spiro-PBD, BALq, and SALq, but is not limited thereto.

[0082] The electron injection layer **179** is disposed on the electron-transporting layer **177**. The electron injection layer **179** serves to enhance electron injection to the electron-transporting layer **177** from the second electrode **180**. In the present exemplary embodiment, the electron injection layer **179** includes a dipole material and a first metal. In one embodiment, the dipole material and the first metal are co-deposited to form one layer. The first metal may include at least one selected from the group consisting of Yb, Mg, Li, Na, Ca, Sr, Ba, In, Sn, La, Ce, Pr, Nd, Pm, Eu, Gd, Tb, Dy, Ho, Er, Sm, and Lu.

[0083] The dipole material consists of a first component and a second component of different polarities, which are combined with each other, and the first component may include one selected from an alkali metal, an alkali earth metal, a rare-earth metal, and a transition metal, and the second component may include a halogen. The first component may be an element including at least one selected from the group consisting of Li, Na, K, Rb, Cs, Be, Mg, Ca, Sr, and Ba, and the second component may be an element including at least one selected from the group consisting of F, Cl, Br, and I. Here, the first component is an element that becomes a cation when the dipole material is ionized, and the second component may be an element that becomes an anion.

[0084] In the present exemplary embodiment, the thickness of the electron injection layer **179** is at least about 5 angstroms (Å) considering a process margin and has a maximum value of about 50 angstroms (Å) by considering the difficulty as a function of the electron injection layer, and thereby a range thereof may be about 5 angstroms (Å) to about 50 angstroms (Å). In one embodiment, the thickness of the electron injection layer is about 10 angstroms (Å) to about 20 angstroms (Å).

[0085] The second electrode **180** is disposed on the electron injection layer **179**. The second electrode **180** included in the organic light emitting diode according to the exemplary embodiment of the present disclosure includes at least one selected from the group consisting of Ag, Al, Mg, Cr, Mn, Fe, Co, Ni, Cu, In, Sn, Ru, Mo, and Nb. The thickness of the second electrode **180**, which is a common electrode, may be about 30 angstroms (Å) to about 300 angstroms (Å). In the present exemplary embodiment, the second electrode **180** may be deposited by sputtering.

[0086] FIG. 4 illustrates a cross-sectional view of another exemplary embodiment in which the organic light emitting diode of FIG. 3 is partially modified.

[0087] Referring to FIG. 4, a shape in which a light-emitting layer **175'** of a light-emitting diode layer **170'** of an organic light emitting diode is modified from that of the light-emitting layer **175** described with reference to FIG. 3 is shown. That is, in the present exemplary embodiment, the light-emitting layer **175'** includes a red light-emitting layer (R), a green light-emitting layer (G), and a blue light-emitting layer (B), and an auxiliary layer (BIL) may be disposed below the blue light-emitting layer (B) such that efficiency of the blue light-emitting layer (B) may be improved.

[0088] The red light-emitting layer (R) may be about 30 nm to about 50 nm thick, the green light-emitting layer (G) may be about 10 nm to about 30 nm thick, and the blue light-emitting layer (B) may be about 10 nm to about 30 nm thick. The auxiliary layer (BIL) disposed below the blue light-emitting layer (B) may be equal to or less than about 20 nm thick. The auxiliary layer (BIL) may improve the efficiency of the blue light-emitting layer (B) by adjusting hole charge balance. The auxiliary layer (BIL) may include a compound represented by Chemical Formula 1.

[0089] In Chemical Formula 1, A1, A2, and A3 are each an alkyl group, an aryl group, carbazole, dibenzothiophene, dibenzofuran (DBF), and biphenyl, and a, b, and c are each positive numbers of zero to four.

[0090] As an example of the compounds represented by Chemical Formula 1, the following Chemical Formulas 1-1, 1-2, 1-3, 1-4, 1-5, and 1-6 may be included.

Chemical Formula 1-1

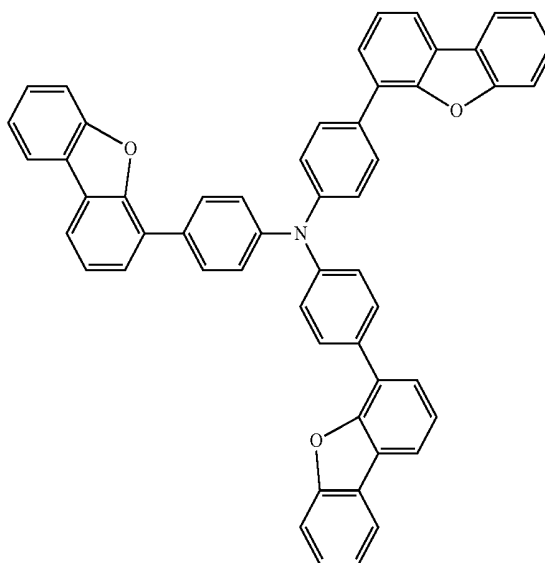

Chemical Formula 1-2

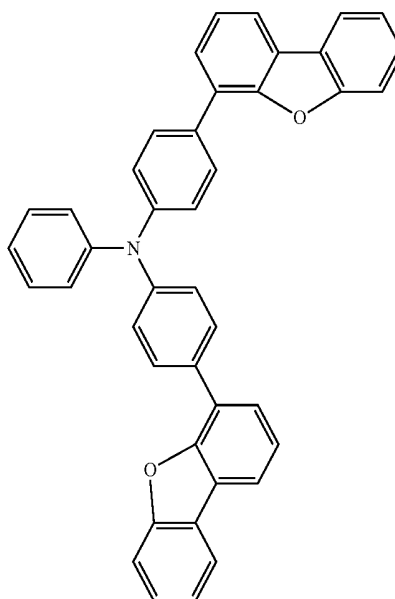

Chemical Formula 1

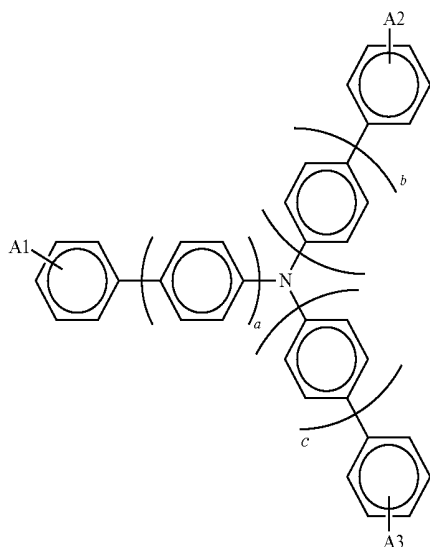

-continued

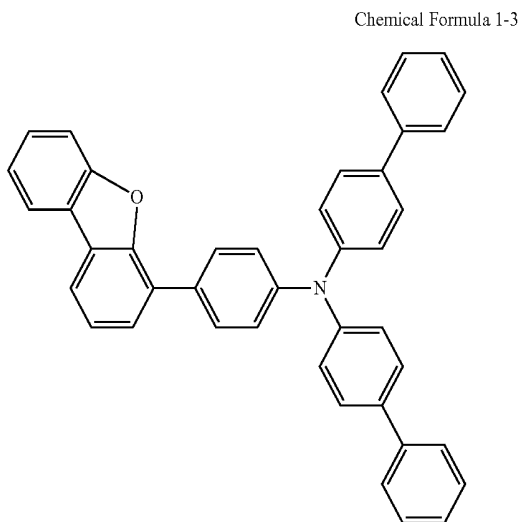

-continued

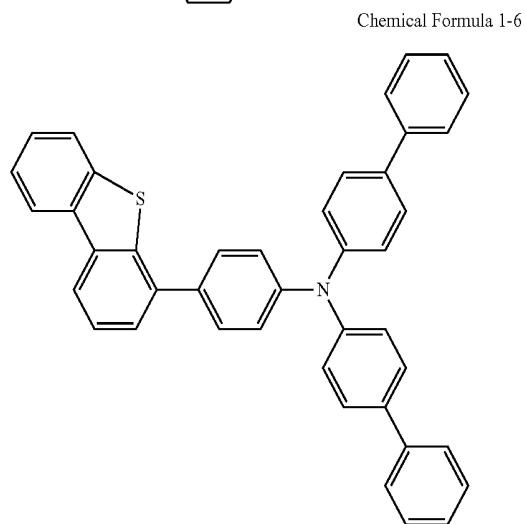
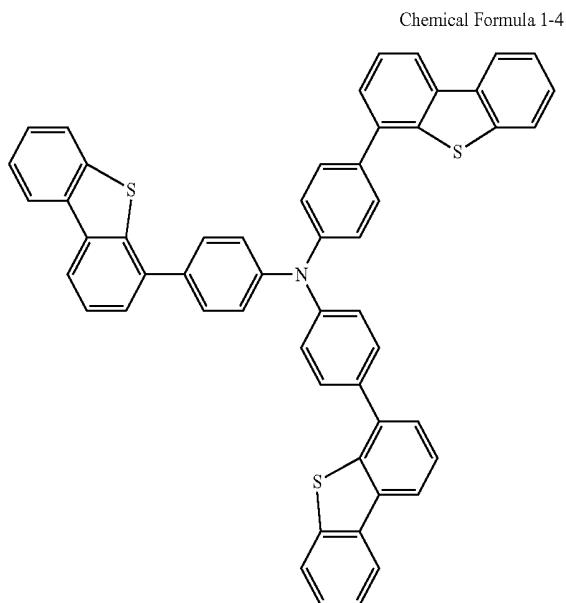
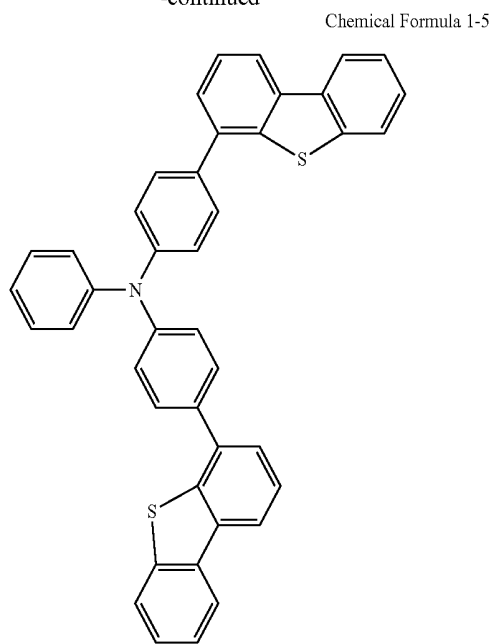

[0091] In another exemplary embodiment, the auxiliary layer (BIL) may include a compound represented by Chemical Formula 2.

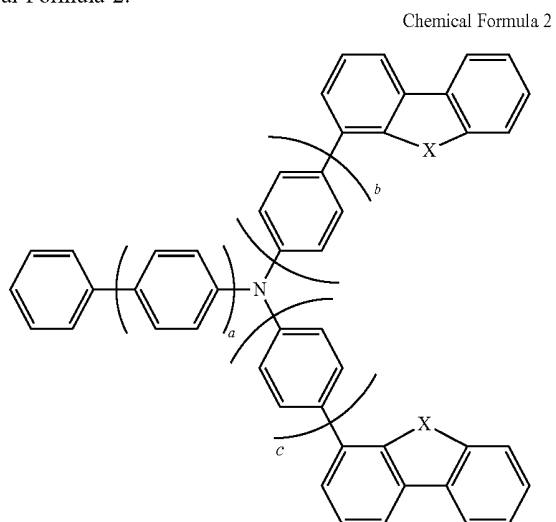

[0092] In Chemical Formula 2, a may be 0 to 3, b and c may respectively be 0 to 3, X may be selected from O, N, or S, and each X may be the same as the other or different than the other.

[0093] As an example of the compound represented by Chemical Formula 2, Chemical Formulas 2-1, 2-2, 2-3, 2-4, 2-5, and 2-6 may be included.

Chemical Formula 2-1

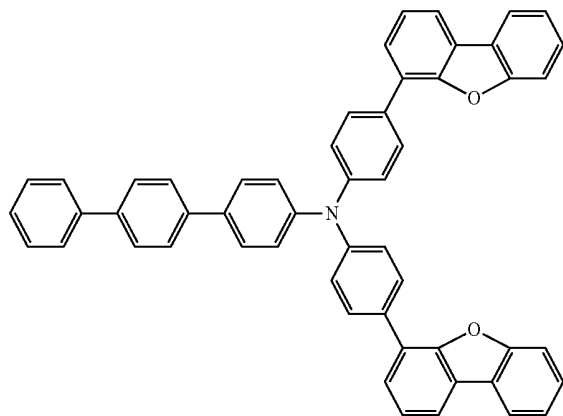

Chemical Formula 2-2

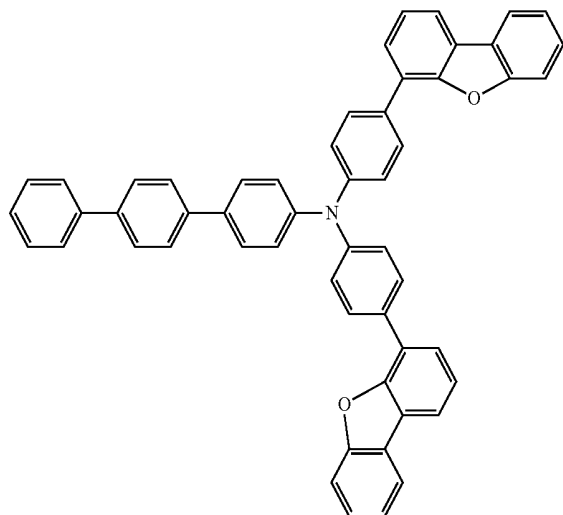

Chemical Formula 2-3

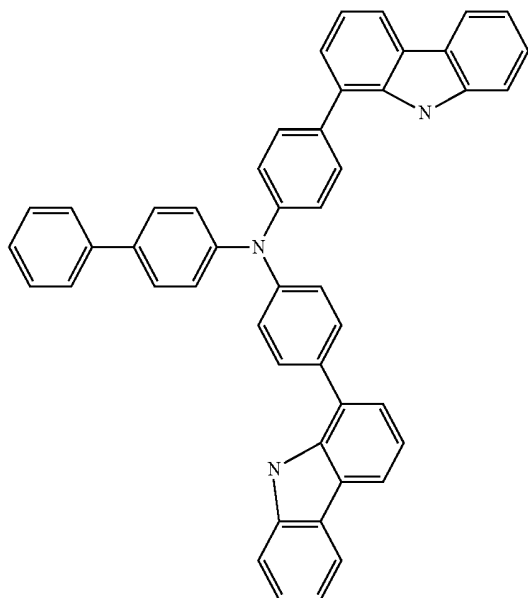

-continued

Chemical Formula 2-4

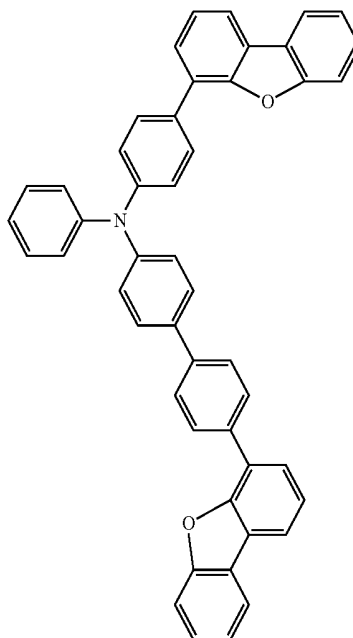

Chemical Formula 2-5

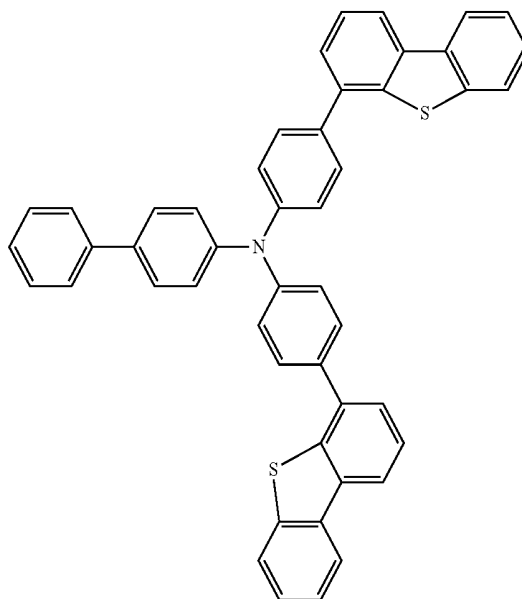

-continued

Chemical Formula 2-6

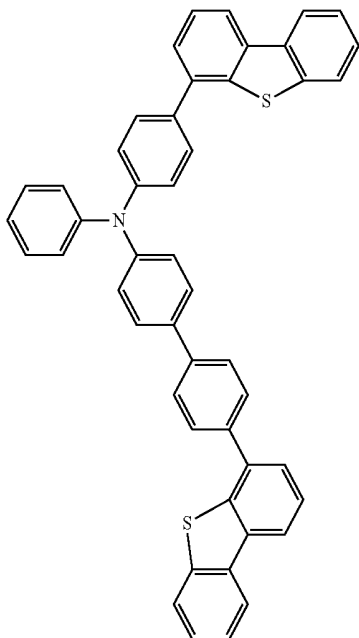

[0094] In another exemplary embodiment, the auxiliary layer (BIL) may include a compound represented by Chemical Formula 3.

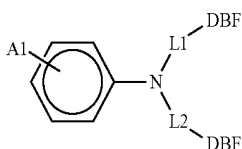

Chemical Formula 3

[0095] In Chemical Formula 3, A1 may be an alkyl group, an aryl group, carbazole, dibenzothiophene, or dibenzofuran (DBF), L1 and L2 may be

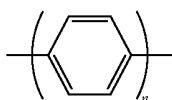

(wherein n is 0 to 3), and DBF connected to L1 and L2 may be replaced by carbazole or dibenzothiophene.

[0096] Hereinafter, a composition method of the auxiliary layer (BIL) according to an exemplary embodiment of the present disclosure will be described. For example, the composition method of the following Chemical formula 1-1 will be described.

Chemical Formula 1-1

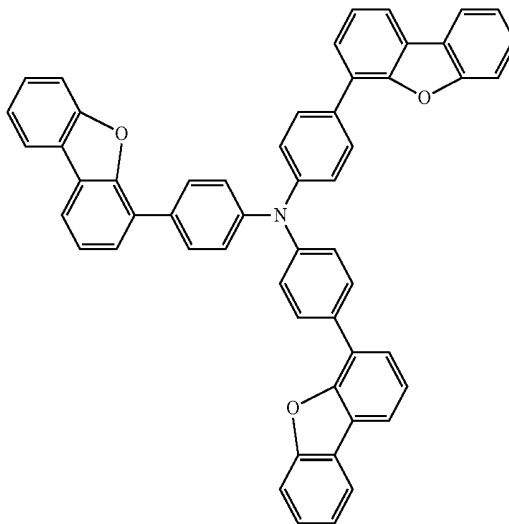

Composition Example

[0097] Under an argon atmosphere, 4-dibenzofuran boronic acid at 6.3 g, 4,4',4''-tribromotriphenylamine at 4.8 g, tetrakis(triphenylphosphine)palladium (Pd(PPh₃)₄) at 104 mg, a sodium carbonate (Na₂CO₃) solution at 48 ml (2 M), and toluene at 48 ml were put in a 300 ml 3-neck flask, and reacted at 80° C. for eight hours. The reaction solution was extracted with toluene/water, and dried with anhydrous sodium sulfate. The resultant was condensed under low pressure, and 3.9 g of a yellowish-white powder was obtained through column purification of the obtained crude product.

[0098] In FIG. 4, a red resonant auxiliary layer (R') may be disposed below the red light-emitting layer (R), and a green resonant auxiliary layer (G') may be disposed below the green light-emitting layer (G). The red resonant auxiliary layer (R') and the green resonant auxiliary layer (G') are layers that are added in order to adjust a resonant distance for each color. A resonant auxiliary layer may not be formed below the blue light-emitting layer (B) and the auxiliary layer (BIL).

[0099] The contents described above with respect to FIGS. 1 to 3, as well as the above-described difference, may be applied to the exemplary embodiment of FIG. 4.

[0100] FIG. 5 illustrates a cross-sectional view of another exemplary embodiment in which the capping layer of the organic light emitting diode display of FIG. 2 is partially modified.

[0101] In the exemplary embodiment of FIG. 5, a capping layer 190' includes multiple layers with different refractive indexes. The capping layer 190' improves light efficiency by increasing an extraction rate of light emitted from the light-emitting diode layer 170 of the organic light emitting diode LD.

[0102] In one embodiment, the capping layer 190' has a structure in which a low refraction layer 190a and a high refraction layer 190b are alternately stacked. Although one low refraction layer 190a and one high refraction layer 190b are shown in FIG. 5, embodiments of the capping layer 190' are not limited thereto, and the capping layer 190' may be

formed as three or more layers, including one or more of the low refraction layer **190a** and one or more of the high refraction layer **190b**.

[0103] In the present exemplary embodiment, the low refraction layer **190a** may include an inorganic material with a refractive index which is equal to or greater than about 1.0 and equal to or less than about 1.7. An inorganic material used in the low refraction layer **190a** may include a halogen compound. For example, the inorganic material used in the low refraction layer **190a** may include at least one selected from the group consisting of MgF_2 , LiF , AlF_3 , and NaF . However, the inorganic material used in the low refraction layer **190a** is not limited thereto, and the low refraction layer **190a** may include a Group I, Group II, lanthanide, or transition metal based halogen compound, for example, KF , PbF , CaF_2 , SrF_2 , YbF_2 , and the like.

[0104] The high refraction layer **190b** is disposed on the farthest top layer from the organic light emitting diode LD. That is, in one embodiment, the high refraction layer **190b** is the topmost layer of the capping layer **190'**. However, in another embodiment, the topmost layer of the capping layer **190'** may be the low refraction layer. This is because it is possible to form a three-layered structure of low refraction layer/high refraction layer/low refraction layer according to an exemplary variation of the present exemplary embodiment.

[0105] The high refraction layer **190b** may include an inorganic material with a refractive index which is equal to or greater than about 1.7 and equal to or less than about 6.0.

[0106] An inorganic material used in the high refraction layer **190b** may, for example, include at least one selected from the group consisting of CuI , thallium iodide (TII), BaS , Cu_2O , CuO , BiI , and WO_3 . However, the high refraction layer **190b** is not limited to the above-described exemplary embodiment, and the high refraction layer **190b** may include at least one selected from the group consisting of TiO_2 , AgI , CdI_2 , HgI_2 , SnI_2 , PnI_2 , BiI_3 , ZnI_2 , MoO_3 , Ag_2O , CdO , CoO , Pr_2O_3 , SnS , PbS , CdS , CaS , ZnS , ZnTe , PbTe , CdTe , SnSe , PbSe , CdSe , AlAs , GaAs , InAs , GaP , InP , AlP , AlSb , GaSb , and InSb .

[0107] In the present exemplary embodiment, the low refraction layer **190a** has a thickness of about 100 angstroms to about 400 angstroms, and the high refraction layer **190b** has a thickness of about 400 angstroms to about 800 angstroms. When the low refraction layer **190a** and the high refraction layer **190b** respectively have the above-described thicknesses, efficiency of light which is emitted from the light-emitting diode layer **170** and passes through the capping layer **190'** may increase by at least 90%. However, the thicknesses of the capping layer **190'** according to the exemplary embodiment of the present disclosure are not limited thereto. That is, thicknesses of the low refraction layer **190a** and the high refraction layer **190b** may be appropriately adjusted, as necessary.

[0108] One portion of light emitted from the light-emitting diode layer **170** by a refractive index difference between the low refraction layer **190a** and the high refraction layer **190b** of the capping layer **190'** may transmit through the capping layer **190'**, and the other portion thereof may be reflected

from the capping layer **190'**. Specifically, light is reflected from an interface between the low refraction layer **190a** and the high refraction layer **190b**, or an interface between the high refraction layer **190b** and the base layer **121a**.

[0109] Light reflected from the capping layer **190'** is again reflected from the first electrode **160** or the second electrode **180**, and this process is repeated, thereby amplifying light. Further, reflection of light may be repeated inside the capping layer **190'**, thereby amplifying light. That is, reflection of light may be repeated between the interface between the low refraction layer **190a** and the high refraction layer **190b** and the interface between the high refraction layer **190b** and the base layer **121a**.

[0110] The organic light emitting diode display according to the exemplary embodiment of the present disclosure may effectively amplify light through such resonance effect, thereby improving light efficiency.

[0111] Since light is reflected from each of the interface between the low refraction layer **190a** and the high refraction layer **190b** and the interface between the high refraction layer **190b** and the base layer **121a** due to the refractive index difference between the low refraction layer **190a** and the high refraction layer **190b** and the refractive index difference between the high refraction layer **190b** and the base layer **121a**, the low refraction layer **190a** and the high refraction layer **190b** preferably have different refractive indexes. The base layer **121a**, which directly contacts the high refraction layer **190b**, may be formed of a low refractive material.

[0112] Therefore, each of the low refraction layer **190a** and the high refraction layer **190b** has a refractive index of a range (e.g., a predetermined range) based on a refractive index of the base layer **121a** and characteristics of a material that is used for manufacturing each of the refraction layers **190a** and **190b**. That is, the refractive index of the high refraction layer **190b** may be equal to or greater than about 1.7 and equal to or less than about 6.0 depending on the component of the high refraction layer **190b**. The refractive index of the low refraction layer **190a** may be equal to or greater than about 1.0 and less than about 1.7 depending on the component of the low refraction layer **190a**. In this case, even if the low refraction layer **190a** and the high refraction layer **190b** are formed of the same material, their refractive indexes may be different from each other depending on a manufacturing method thereof.

[0113] The contents described with respect to FIG. 2, as well as the above-described difference, may be applied to the exemplary embodiment of FIG. 5.

[0114] As described in the exemplary embodiment of the present disclosure, compared to the capping layer that is formed of an inorganic material, and the top layer of which is designed to have a refractive index different from that of the base layer of the thin film encapsulation layer, Table 1 represents changes of light efficiency of the capping layer formed of an organic material.

TABLE 1

		Comparative Example 1	Comparative Example 2	Exemplary Embodiment 1	Exemplary Embodiment 2	Exemplary Embodiment 3	Exemplary Embodiment 4
Thin film encapsulation layer	Third encapsulation layer	SiNx	SiNx	SiNx	SiNx	SiNx	SiNx
	Second encapsulation layer	Organic material	Organic material	Organic material	Organic material	Organic material	Organic material
	First encapsulation layer	SiON	SiON	SiNx	SiON	SiON	SiNx
Capping layer	Base layer	LiF	LiF	LiF	LiF	LiF	LiF
	Upper layer	Organic material 1	Organic material 2	TiOx	CuI	CuI	CuI
	Lower layer	—	Balq	—	—	AlF ₃	AlF ₃
	Relative light efficiency	0.84	0.91	1.01	0.93	0.98	1.03

[0115] Referring to Table 1, Comparative Example 1 is a capping layer that is formed as a single layer with a first organic material, and Comparative Example 2 is a capping layer that is formed as a two-layered structure with a second organic material such as Balq. In this case, each of the first organic material and the second organic material may be a material applied to a conventional manufactured capping layer among organic materials having a refractive index of about 1.88 to about 1.90. Light efficiency of Comparative Examples 1 and 2 that are the capping layers formed of the organic material are respectively measured at about 0.84 and about 0.91, while light efficiency of Exemplary Embodiments 1, 2, 3, and 4 increases. In Table 1, an acryl-based organic material is used as the organic material of the second encapsulation layer. In this case, the acryl-based organic material may be an ultraviolet ray-hardened type of organic material.

[0116] An epoxy-based organic material may be used instead of the acryl-based organic material.

[0117] While this disclosure has been described in connection with what are presently considered to be some practical exemplary embodiments, it is to be understood that the disclosure is not limited to the disclosed embodiments, but, on the contrary, is intended to cover various modifications and equivalent arrangements included within the spirit and scope of the appended claims and equivalents thereof.

What is claimed is:

1. An organic light emitting diode display comprising:
 - a substrate;
 - an organic light emitting diode on the substrate;
 - a capping layer on the organic light emitting diode and including a high refractive layer comprising an inorganic material having a refractive index that is equal to or greater than about 1.7 and equal to or less than about 6.0; and
 - a thin film encapsulation layer covering the capping layer and the organic light emitting diode, and
 wherein the inorganic material comprises at least one selected from the group consisting of CuI, thallium iodide (TlI), BaS, Cu₂O, CuO, BiI, WO₃, AgI, CdI₂, HgI₂, SnI₂, PbI₂, BiI₃, ZnI₂, MoO₃, Ag₂O, CdO, CoO, Pr₂O₃, SnS, PbS, CdS, CaS, ZnS, ZnTe, PbTe, CdTe, SnSe, PbSe, CdSe, AlAs, GaAs, InAs, GaP, InP, AlP, AlSb, GaSb, and InSb,
 - wherein the capping layer is a single layer.

2. The organic light emitting diode display of claim 1, wherein:

the capping layer comprises a top layer directly below the thin film encapsulation layer, the thin film encapsulation layer comprises a base layer directly on the capping layer; and

the top layer and the base layer have different refractive indexes from each other.

3. The organic light emitting diode display of claim 2, wherein:

the thin film encapsulation layer comprises a first encapsulation layer on the base layer, a second encapsulation layer on the first encapsulation layer, and a third encapsulation layer on the second encapsulation layer; and

the first encapsulation layer is an inorganic layer; the second encapsulation layer is an organic layer; and the third encapsulation layer is an inorganic layer.

4. The organic light emitting diode display of claim 3, wherein the base layer comprises at least one selected from the group consisting of LiF, SiOx, SiC, MgF₂, AlF₃, and NaF.

5. The organic light emitting diode display of claim 4, wherein the first encapsulation layer comprises at least one selected from the group consisting of SiON, TiO₂, and SiNx.

6. The organic light emitting diode display of claim 5, wherein the third encapsulation layer comprises at least one selected from the group consisting of SiON, SiNx, and TiO₂.

7. The organic light emitting diode display of claim 1, wherein:

the organic light emitting diode comprises a first electrode and a second electrode facing each other, and a light-emitting layer between the first electrode and the second electrode; and

the capping layer is directly on the second electrode.

8. The organic light emitting diode display of claim 7, wherein the first electrode comprises a reflective layer.

9. The organic light emitting diode display of claim 8, wherein the thin film encapsulation layer covers a lateral surface of the capping layer.

10. The organic light emitting diode display of claim 9, wherein the light-emitting layer comprises a red light-emitting layer, a green light-emitting layer, a blue light-emitting layer, and an auxiliary layer that is below the blue light-emitting layer.

11. The organic light emitting diode display of claim 10, further comprising a red resonant auxiliary layer below the red light-emitting layer and a green resonant auxiliary layer below the green light-emitting layer.

12. The organic light emitting diode display of claim 10, wherein the auxiliary layer comprises a compound represented by Chemical Formula 1:

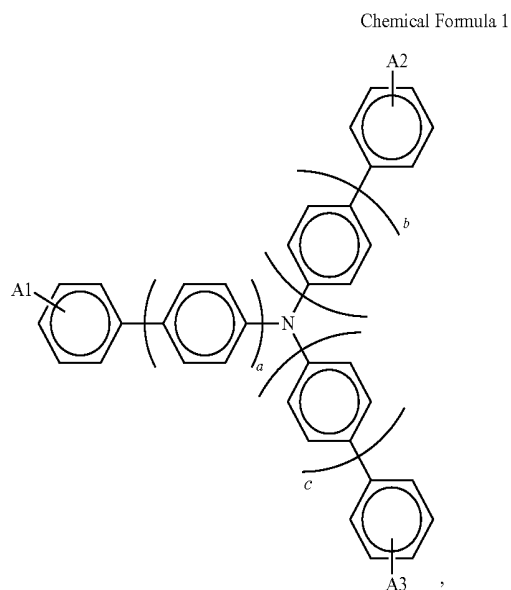

wherein, in Chemical Formula 1, A1, A2, and A3 are each an alkyl group, an aryl group, carbazole, dibenzothio-

phene, dibenzofuran (DBF), and biphenyl, and a, b, and c are each positive numbers of zero to four.

13. The organic light emitting diode display of claim 10, wherein the auxiliary layer comprises a compound represented by Chemical Formula 2:

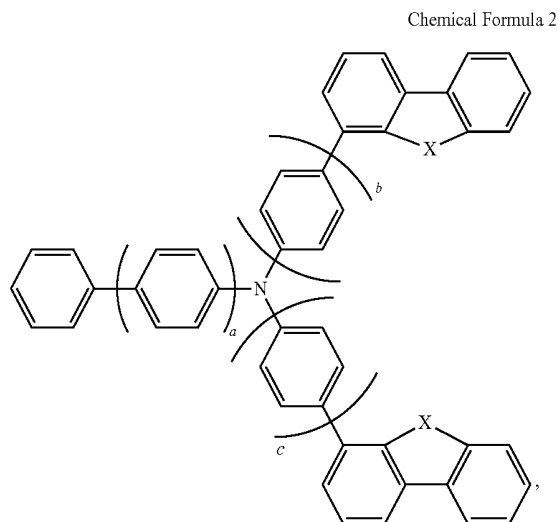

wherein, in Chemical Formula 2, a is 0 to 3, b and c are respectively 0 to 3, X is selected from O, N, or S, and each X is the same as the other or different than the other.

* * * * *

专利名称(译)	有机发光二极管显示器		
公开(公告)号	US20190305254A1	公开(公告)日	2019-10-03
申请号	US16/427978	申请日	2019-05-31
[标]申请(专利权)人(译)	三星显示有限公司		
申请(专利权)人(译)	三星DISPLAY CO. , LTD.		
当前申请(专利权)人(译)	三星DISPLAY CO. , LTD.		
[标]发明人	KIM WON JONG KIM DONG CHAN KIM EUNG DO SEO DONG KYU IM DA HEA YIM SANG HOON CHO YOON HYEUNG HAN WON SUK		
发明人	KIM, WON JONG KIM, DONG CHAN KIM, EUNG DO SEO, DONG KYU IM, DA HEA YIM, SANG HOON CHO, YOON HYEUNG HAN, WON SUK		
IPC分类号	H01L51/52 H01L51/00		
CPC分类号	H01L51/0073 H01L51/5262 H01L51/0072 H01L51/50 H01L51/5253 H01L51/0061 H01L2251/5315 H01L51/5275 H01L51/0074 H01L27/3211		
优先权	1020150090722 2015-06-25 KR		
外部链接	Espacenet USPTO		

摘要(译)

一种有机发光二极管显示器，包括：基板；基板上的有机发光二极管；覆盖层在有机发光二极管上，并包括高折射率层，该高折射率层包括折射率等于或大于约1.7且小于或等于约6.0的无机材料；无机材料包括选自CuI，碘化th (TII) ， BaS ， Cu₂ 中的至少一种；以及覆盖所述覆盖层和有机发光二极管的薄膜封装层。 ， CuO ， Bil ， WO₃ ， TiO₂ ， AgI ， CdI₂ ， Hgl₂ ， Sni₂ ， Pbl₂ ， Bil₃ ， Znl₂ ， MoO₃ ， Ag₂O ， CdO ， CoO ， Pr₂O₃ ， SnS ， PbS ， CdS ， CaS ， ZnS ， ZnTe ， PbTe ， CdTe ， SnSe ， PbSe ， CdSe ， AlAs ， GaAs ， InAs ， GaP ， InP ， AlP ， AlSb ， GaSb和InSb。

